

FEATURES

- Output voltage $6.3 V_{pp}$
- Flat gain up to 40 GHz
- Single voltage power supply
- Gain and crossing point adjustment

APPLICATIONS

- LiNbO₃ & InP modulators
- 40 Gbps - 44 Gbps NRZ / RZ
- SONET OC-768 / SDH-256
- Research & Development

OPTIONS

- Heat-sink
- Analog version
- Low output voltage version for EAM

RELATED EQUIPMENTS

- MX-LN-40, MXAN-LN-40 modulators
- MBC-DG Automatic Bias Controllers

The DR-DG-40-MO is a driver module optimized for digital applications at 40 Gbps – 44 Gbps data rate. It exhibits an output voltage of $6.3 V_{pp}$ and a broad bandwidth of 40 GHz.

The DR-DG-40-MO is housed in a compact package that integrates voltage regulators allowing for flexible biasing, while internal bias sequencing circuitry assures robust operation and single voltage power supply for maximum ease of use. It features two control inputs: one for gain control, the second one for crossing point adjustment. The RF connectors are V type, allowing easy and repeatable connections.

The DR-DG-40-MO combines high performance and user friendliness, it is the ideal device to drive 40 Gbps modulators and to obtain widely opened optical eye diagrams with short jitter and high SNR.

Performance Highlights

Parameter	Min	Typ	Max	Unit
Cut-off Frequencies	50 k	-	40 G	Hz
Output Voltage	-	6.3	-	V_{pp}
Gain	-	26	-	dB
Saturated Power	20	-	-	dBm
Added Jitter	-	0.75	-	ps
Rise / Fall Times	-	9	12	ps

Measurements for $V_{bias} = 8 V, V_{amp} = 2.1 V, V_{xp} = 1.7 V, I_{bias} = 282 mA$

40 Gbps Output Response

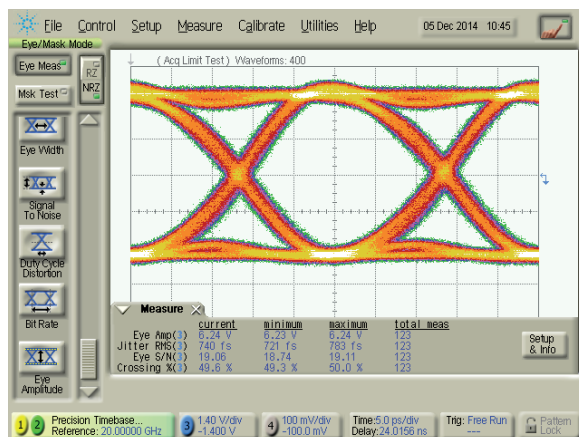

DC Electrical Characteristics

Parameter	Symbol	Min	Typ	Max	Unit
Supply voltage (fixed)	V_{bias}	7	8	12	V
Current consumption	I_{bias}	-	300	350	mA
Gain control voltage	V_{amp}	0	1.5	2	V
Cross point control voltage	V_{xp}	0	0.8	2.5	V

Electrical Characteristics

Parameter	Symbol	Condition	Min	Typ	Max	Unit
Lower frequency	f_{3dB}^{lower}	-3 dB point	-	-	50	kHz
Upper frequency	f_{3dB}^{upper}	-3 dB point	36	40	-	GHz
Gain	S_{21}	Small signal	-	26	-	dB
Gain ripple	-	< 40 GHz	-	±1.5	-	dB
Input return loss	S_{11}	50 MHz < f < 30 GHz	-	-10	-	dB
Output return loss	S_{22}	50 MHz < f < 30 GHz	-	-10	-	dB
Saturated power	P_{sat}	$V_{in} = 0.45 V_{pp}$	20	-	-	dBm
Output voltage	V_{out}	$V_{in} = 0.45 V_{pp}$	-	6.3	6.5	V_{pp}
Rise time / Fall time	t_r / t_f	20 % - 80 %	-	9	12	ps
Added jitter	J_{RMS}	$J_{RMS} = \sqrt{J_{RMS-total}^2 - J_{RMS-source}^2}$	-	0.75	-	ps
Power dissipation	P	$V_{out} = 6.3 V_{pp}$	-	2.4	-	W

Conditions: $V_{in} = 0.65 V_{pp}$, $T_{amb} = 25^\circ C$, 50 Ω system

Absolute Maximum Ratings

Stresses in excess of the absolute maximum ratings can cause permanent damage to the device. These are absolute stress ratings only. Functional operation of the device is not implied at these or any other conditions in excess of those given in the operational sections of the data sheet. Exposure to absolute maximum ratings for extended periods can adversely affect device reliability.

Parameter	Symbol	Min	Max	Unit
RF input voltage	V_{in}	-	1	V_{pp}
Supply Voltage	V_{bias}	0	12	V
DC current	I_{bias}	0	350	mA
Gain control voltage	V_{amp}	0	2	V
Cross point control voltage	V_{xp}	0	2.5	V
Power dissipation	P_{diss}	-	4.2	W
Temperature of operation	T_{op}	0	40	$^\circ C$
Storage temperature	T_{st}	-20	+70	$^\circ C$

S₂₁ Parameter Curve

Conditions: $V_{bias} = 12\text{ V}$, $V_{amp} = 1.5\text{ V}$, $V_{xp} = 0.8\text{ V}$, $I_{bias} = 300\text{ mA}$

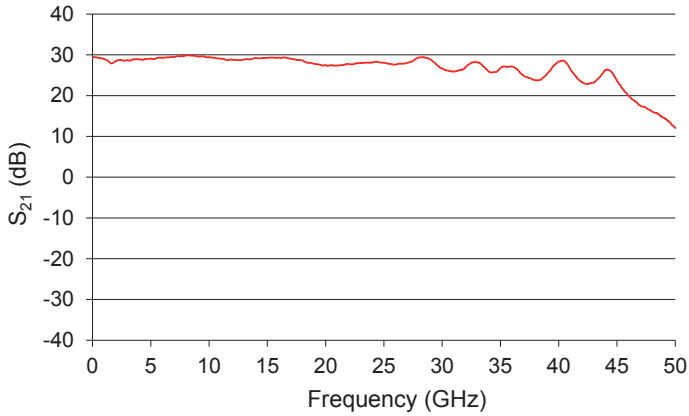

Group Delay Parameter Curve

Conditions: $V_{bias} = 12\text{ V}$, $V_{amp} = 1.5\text{ V}$, $V_{xp} = 0.8\text{ V}$, $I_{bias} = 300\text{ mA}$

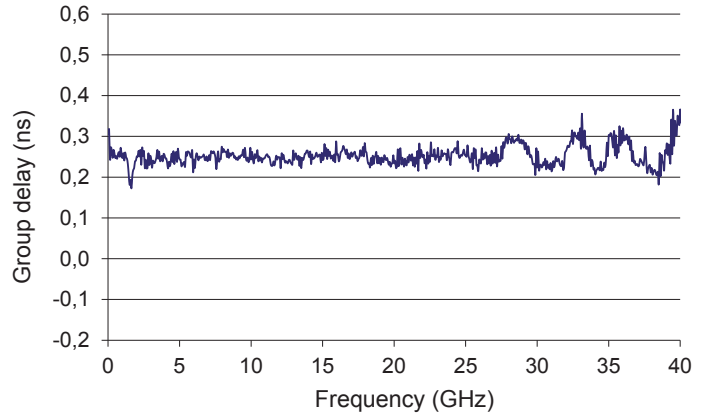

S₂₂ Parameter Curve

Conditions: $V_{bias} = 12\text{ V}$, $V_{amp} = 1.5\text{ V}$, $V_{xp} = 0.8\text{ V}$, $I_{bias} = 300\text{ mA}$

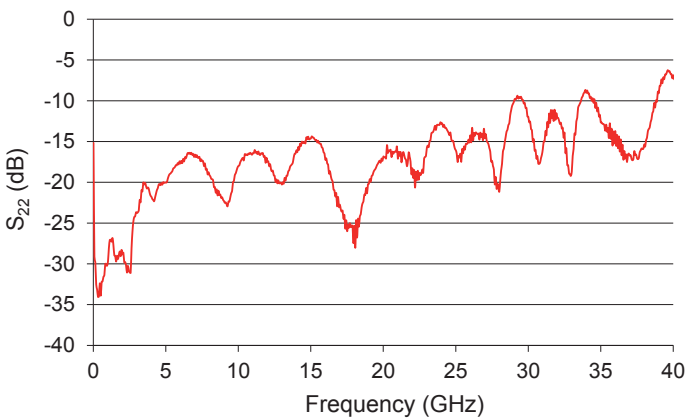

S₁₁ Parameter Curve

Conditions: $V_{bias} = 12\text{ V}$, $V_{amp} = 1.5\text{ V}$, $V_{xp} = 0.8\text{ V}$, $I_{bias} = 300\text{ mA}$

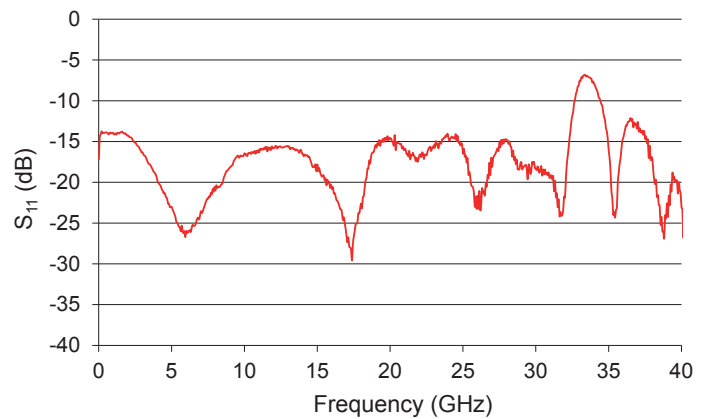

S₁₂ Parameter Curve

Conditions: $V_{bias} = 12\text{ V}$, $V_{amp} = 1.5\text{ V}$, $V_{xp} = 0.8\text{ V}$, $I_{bias} = 300\text{ mA}$

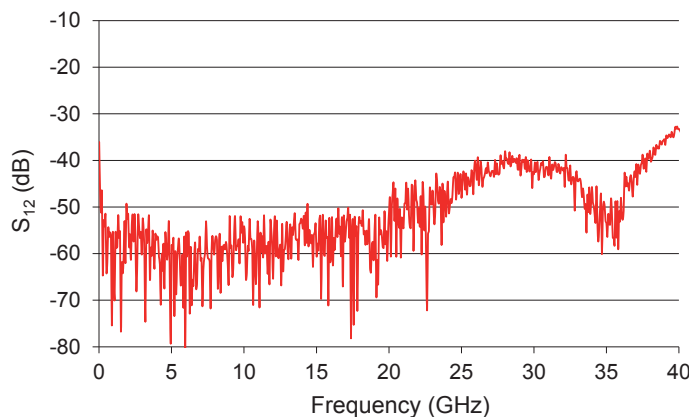

Typical Output Voltage Amplitude VS Gain Control Vamp Tuning

Conditions: $V_{bias} = 12\text{ V}$, $V_{xp} = 1.7\text{ V}$

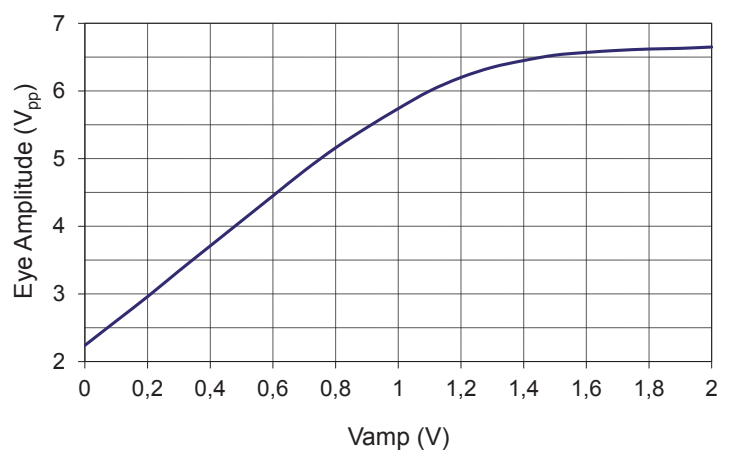

Eye Diagrams

20 Gbps data rate

Conditions: Ratio y, Pattern 2³¹-1
 $V_{bias} = 8\text{ V}, V_{amp} = 2.1\text{ V}, V_{xp} = 1.7\text{ V}, I_{bias} = 282\text{ mA}$

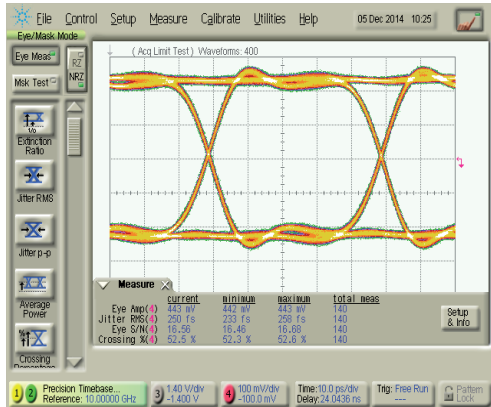

Input signal

Eye amplitude = 0.44 V_{pp} , Rise time = 9 ps
 Jitter RMS = 250 fs, SNR = 16.5

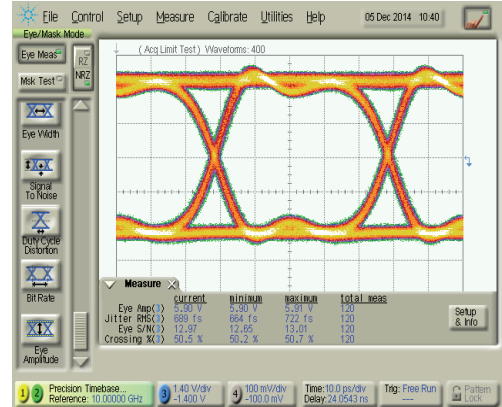

Output response

Eye amplitude = 5.9 V_{pp} , Rise time = 8.89 ps
 Jitter RMS = 689 fs, SNR = 12.97

40 Gbps data rate

Conditions: Ratio y, Pattern 2³¹-1
 $V_{bias} = 8\text{ V}, V_{amp} = 2.7\text{ V}, V_{xp} = 1.7\text{ V}, I_{bias} = 282\text{ mA}$

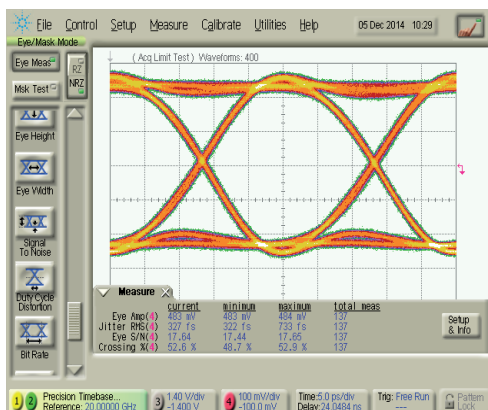

Input signal

Eye amplitude = 0.48 V_{pp} , Rise time = 9.3 ps
 Jitter RMS = 327 fs, SNR = 17.6

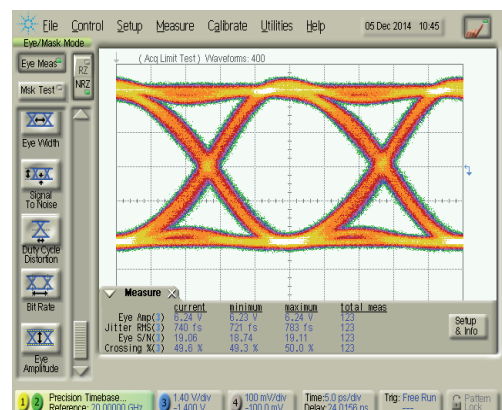

Output response

Eye amplitude = 6.34 V_{pp} , Rise time = 9.11 ps
 Jitter RMS = 740 fs, SNR = 19

Electrical Schematic Diagram

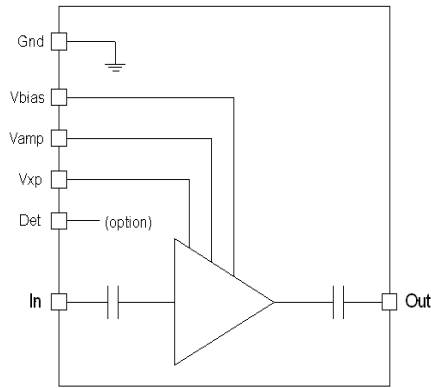

Mechanical Diagram and Pinout

All measurements in mm

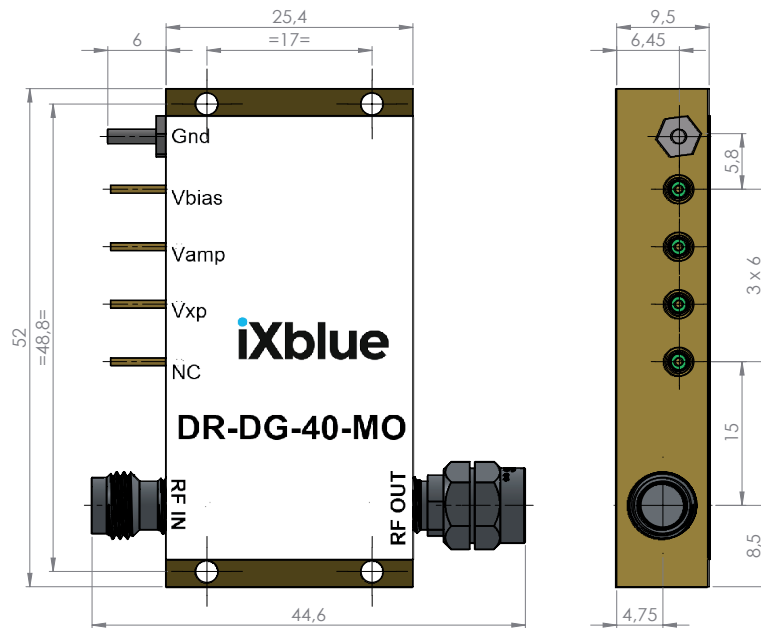

The heatsinking of the module is necessary. It's user responsibility to use an adequate heatsink. Refer to page 6 for ixBlue recommended heatsink.

PIN	Function	Unit
IN	RF In	V connector female
OUT	RF Out	V connector male
V_{bias}	Power supply voltage	Set a typical operating specification
V_{amp}	Output voltage amplitude adjustment	Adjust for gain control tuning
V_{xp}	Output voltage cross point adjustment	Adjust for cross point control tuning

Mechanical Diagram And Pinout With HS-MO2 Heatsink

All measurements in mm

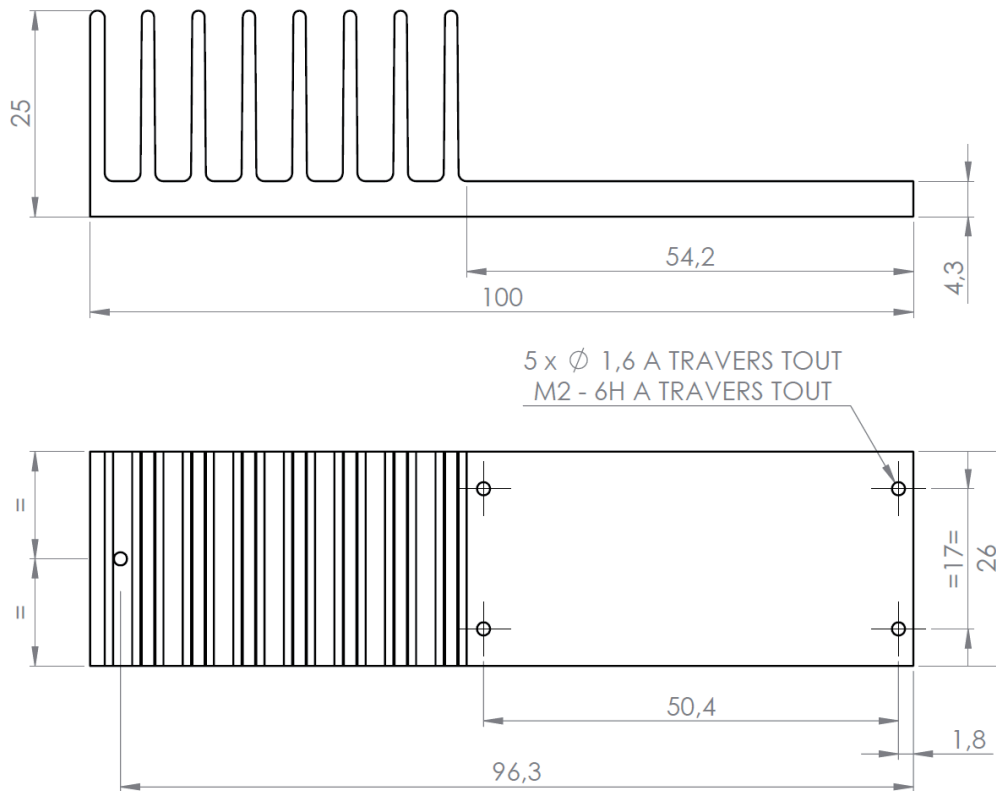
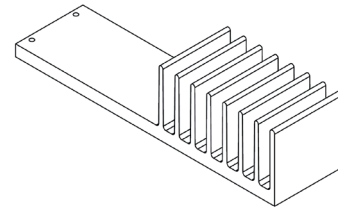

About us

ixBlue Photonics produces specialty optical fibers and Bragg gratings based fiber optics components and provides optical modulation solutions based on the company lithium niobate (LiNbO₃) modulators and RF electronic modules.

ixBlue Photonics serves a wide range of industries: sensing and instruments, defense, telecommunications, space and fiber lasers as well as research laboratories all over the world.